

[med]

med 64.09.60



“MAN 18-284 “

“VOLVO FL6.180 - FL6.220 - FL6.250”

- Con pompa rotativa BOSCH
- With rotative BOSCH pump

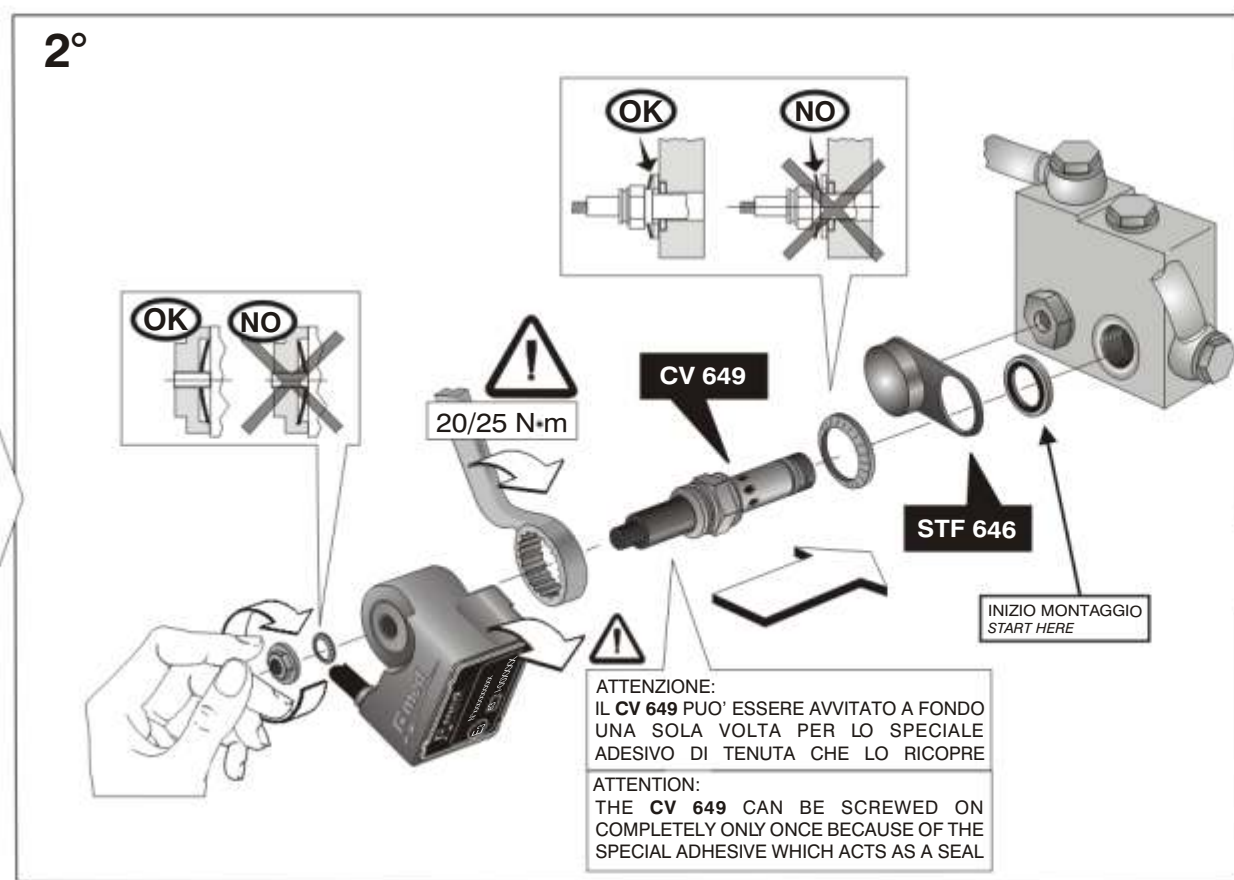
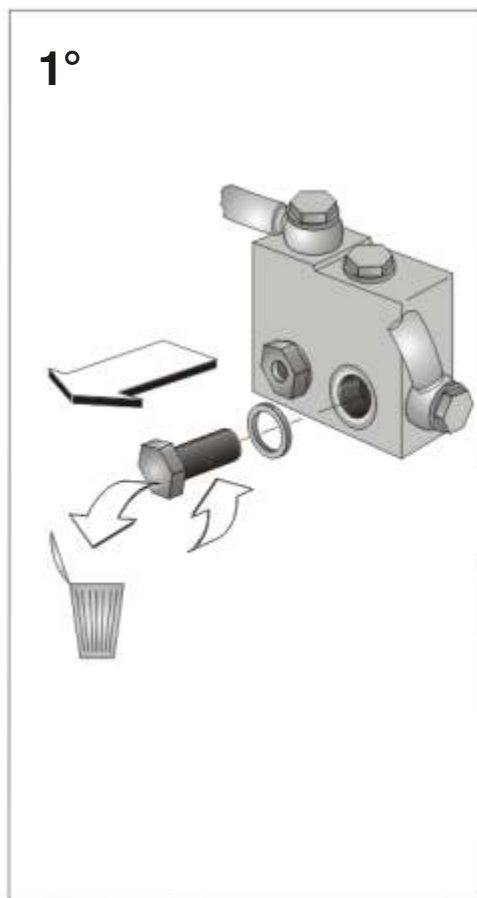
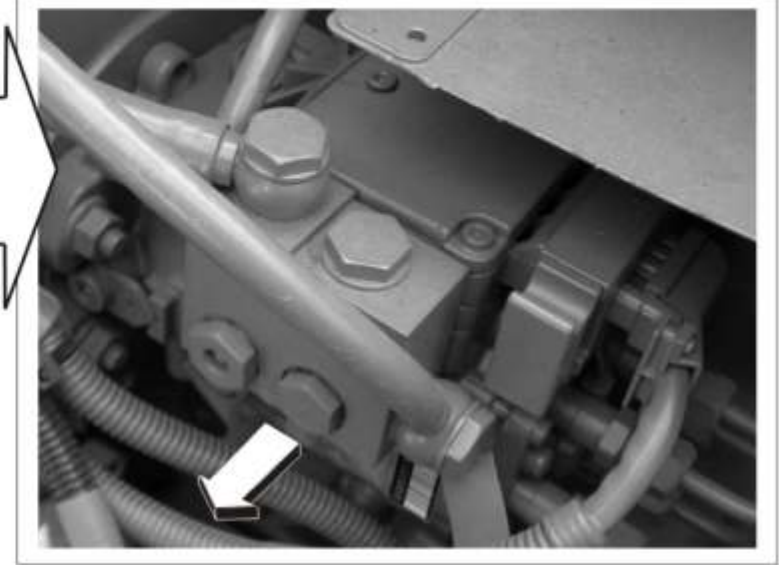
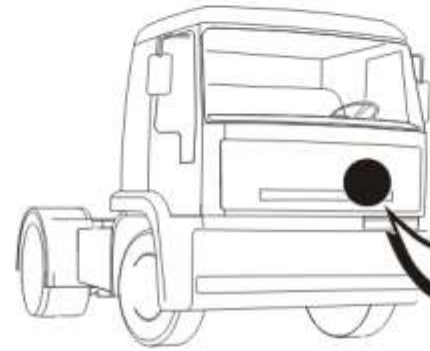

TEST

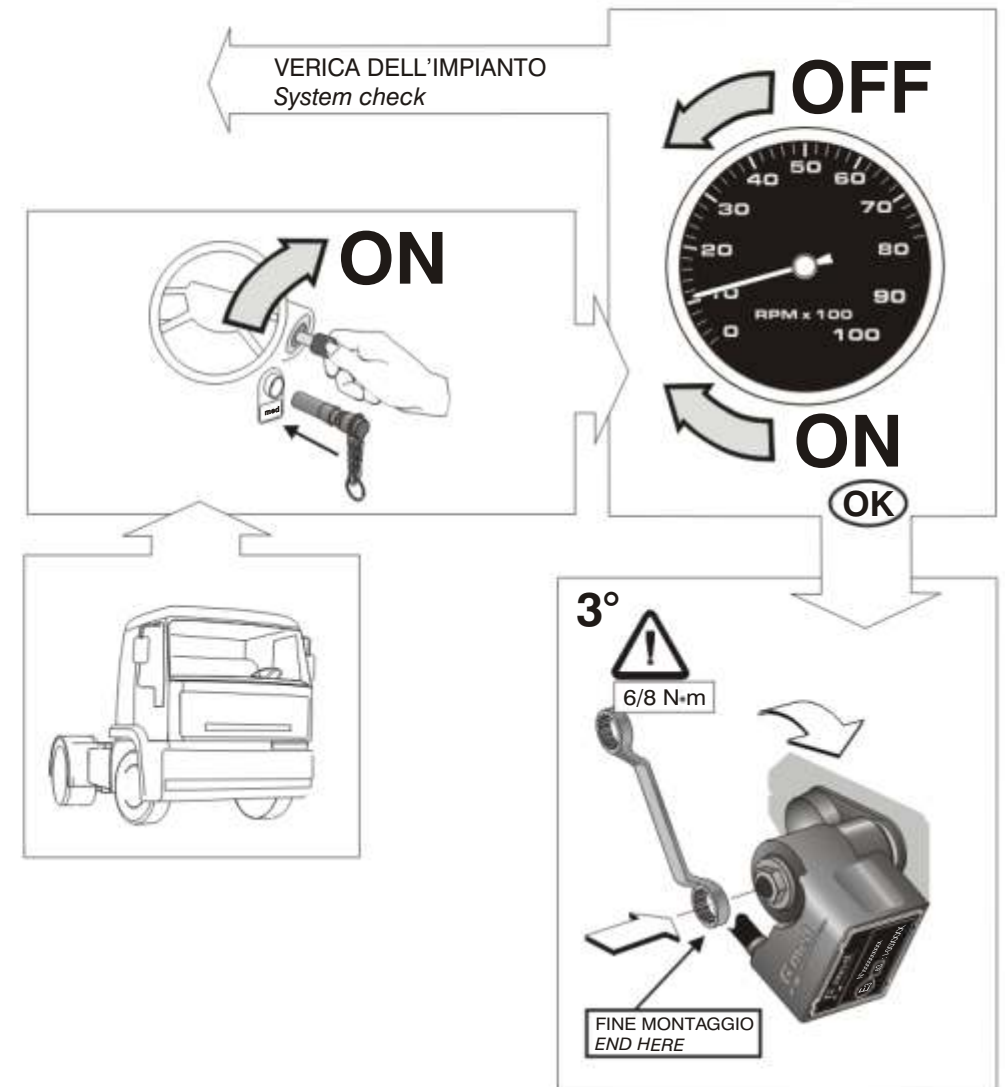

[med]

med S.p.A.
Via Raffaello, 33 - 42100 Reggio Emilia (Italy)
tel. +39 0522 511665 fax +39 0522 500153

www.med-italy.com
e-mail: med.service@med-italy.com

AZIENDA CON SISTEMA QUALITÀ
CERTIFICATO DA DNV
UNI EN ISO 9001

