

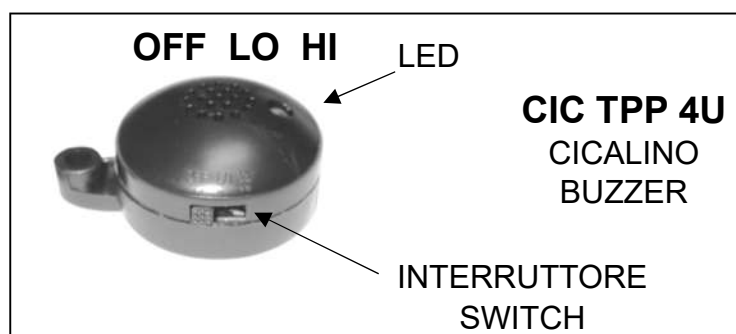

## TOP PARKING PLUS 4U



### ISTRUZIONI DI MONTAGGIO FITTING GUIDE

**Sistema di parcheggio con 4 sensori da incasso per paraurti anteriore o posteriore.**

**Parking system with 4 sensors to embed in front or rear bumper.**

## CONTENUTO DELLA CONFEZIONE - PACKAGING CONTENT

### TOP PARKING PLUS 4U

- 1 x **CNT TPP 4U** = Centralina programmabile - Control Unit
- 4 x **SEN TPP 4U** = Sensori cablati - Sensors wired
- 4 x **CAV SEN TPP 4U** = Cavi prolunga sensori - Sensor extension cable:
  - 1 x **LS** = Sinistro, Laterale - Left
  - 1 x **LC** = Sinistro, Centrale - Left Central
  - 1 x **RC** = Destro, Centrale - Right Central
  - 1 x **RS** = Destro, Laterale - Right
- 1 x **CAV TPP 4U** = Cavo di alimentazione sistema - Cavo di alimentazione sistema
- 1 x **CIC TPP 4U** = Cicalino - Buzzer
- 1 x **CAV CIC TPP 4U** = Cavo di prolunga per cicalino - Buzzer extension cable
- 1 x **PUL TPP 4U** = Pulsante cablato ON / OFF (mute) - ON / OFF (mute) button wired
- 1 x **SAC TPP 4U** = Sacchetto accessori, contenente: - Accessories package, containing:
  - 1 x Velcro adesivo per fissaggio centralina - Adhesive Velcro for mounting control box
  - 1 x Primer
  - 1 x Salviettina detergente - Cleansing towelette
  - 1 x FRONT / REAR - Mostrina per pulsante ON / OFF - Plate for ON / OFF button
  - 8 x Biadesivi di fissaggio sensori - Bi-adhesive stickers
  - 8 x Fascette fissaggio cavi - Cable fixing band
  - 1 x Vite con rondella fissaggio cicalino - Buzzer mounting screws with washer

### DISPLAY TP PLUS 4U - OPZIONALE - OPTIONAL

- 1 x Display con slitta di fissaggio - Display with mounting slide
- 1 x Cavo prolunga display - Display cable extension
- 1 x Sacchetto accessori display, contenente: - Display accessories package, containing:
  - 1 x Biadesivo di fissaggio display - Bi-adhesive display
  - 1 x Salviettina detergente - Cleansing towelette
  - 2 x Fascette fissaggio cavi - Cable fixing band
  - 2 x Viti fissaggio slitta display - Display mounting slide screws

### CHP 205 - OPZIONALE - OPTIONAL

Attrezzo manuale consigliato per effettuare il foro nel paraurti in materiale plastico.

Hand tool recommended for making the hole in the plastic bumper.



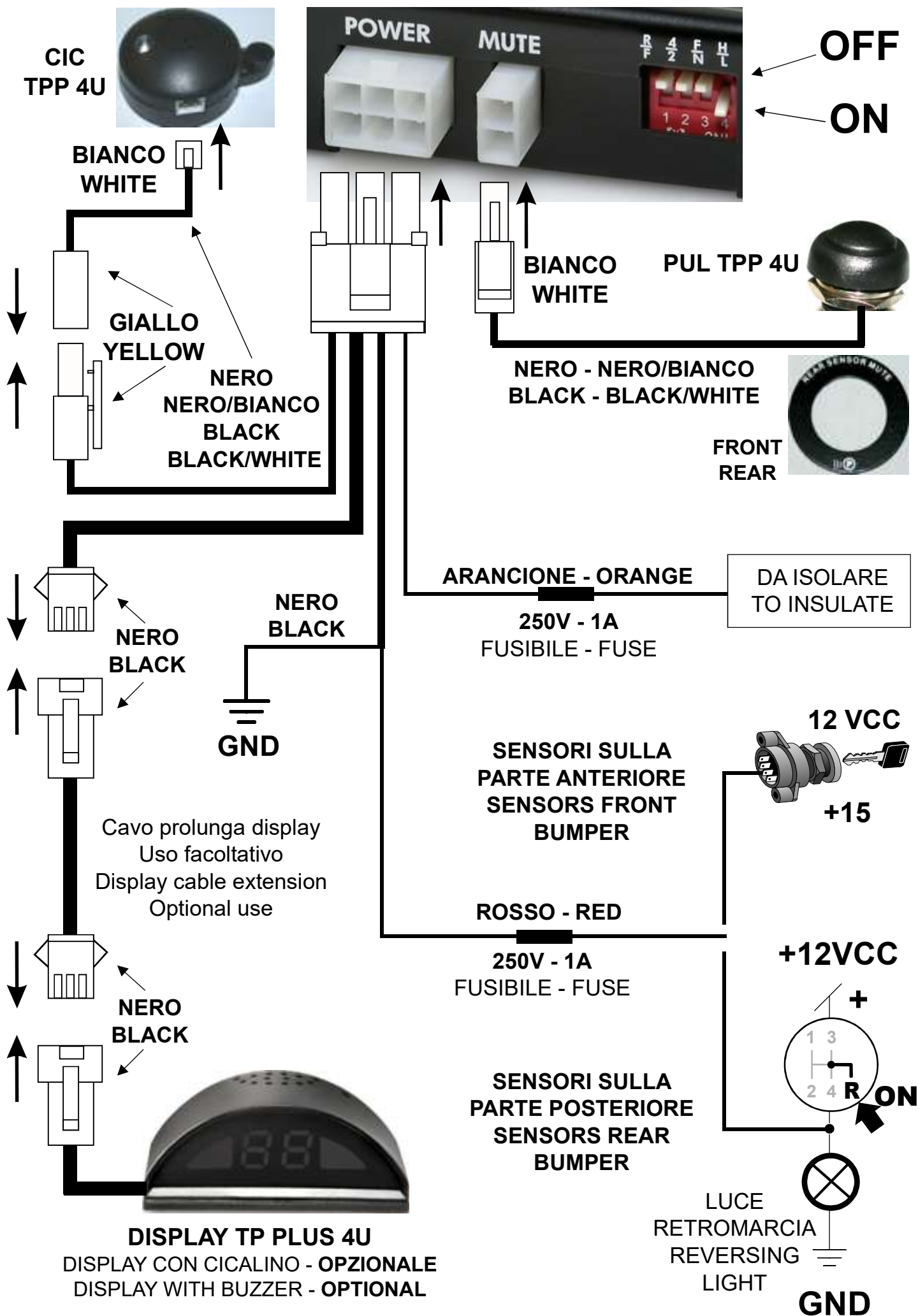

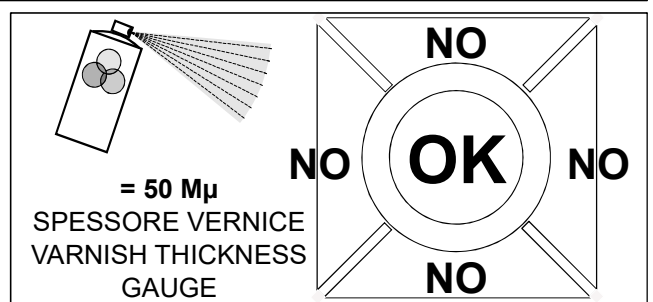
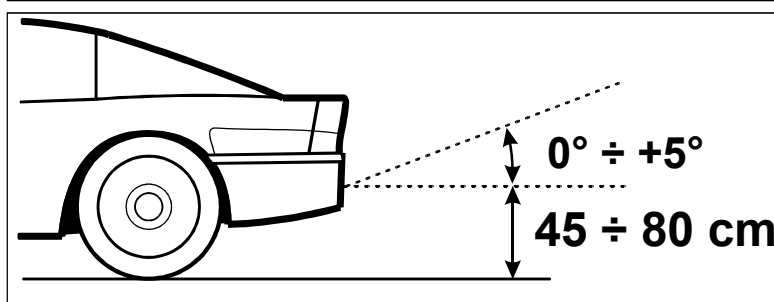
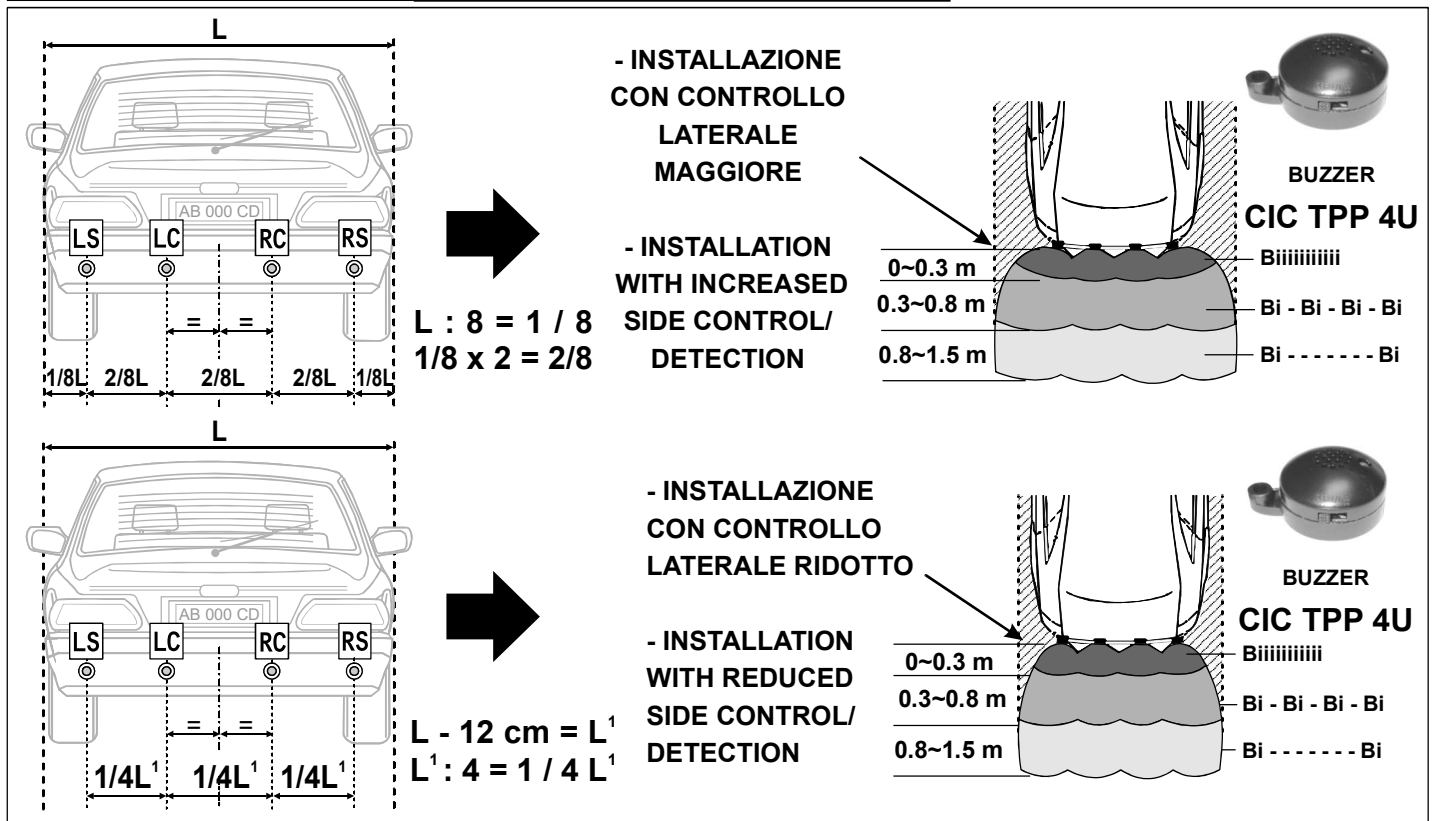
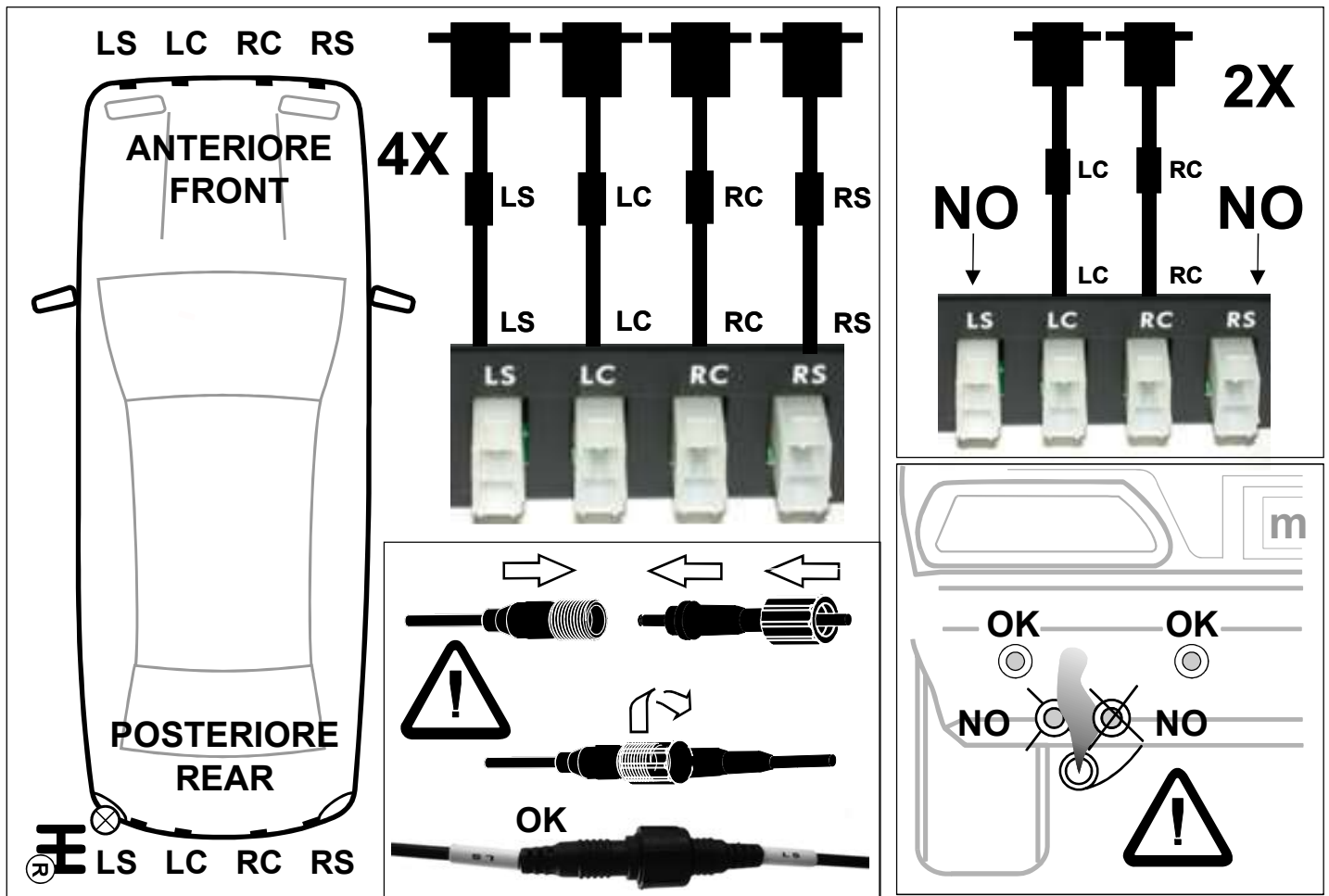

# MONTAGGIO SENSORI - MOUNTING SENSORS

- ATTENZIONE USARE UTENSILI IDONEI  
- WARNING! USE SUITABLE TOOLS



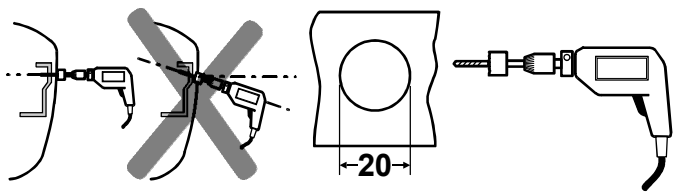

- PUNTA - TWIST DRILL  
Ø 20 mm



- INSTALLAZIONE CONSIGLIATA CON **CHP 205** OPZIONALE  
- RECOMMENDED INSTALLATION WITH OPTIONAL **CHP 205**

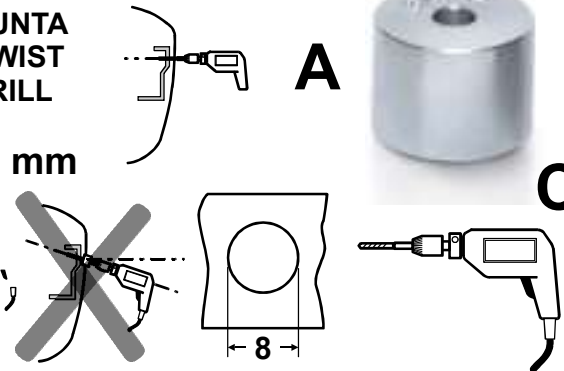

- PUNTA - TWIST DRILL  
Ø 8 mm

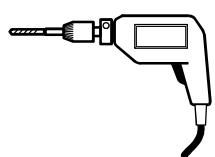

**A** 

**B** 

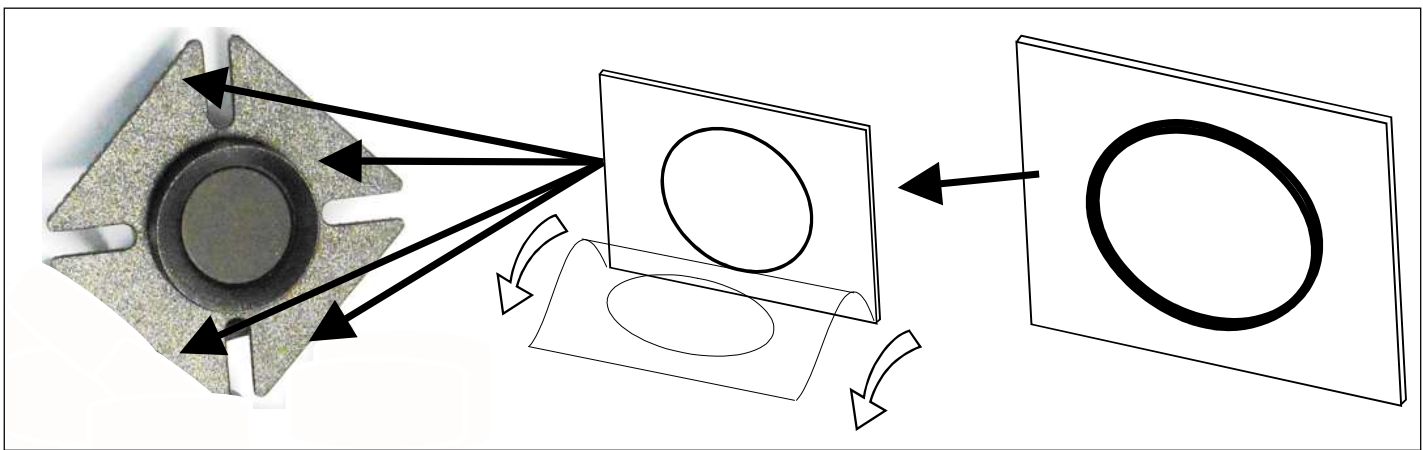
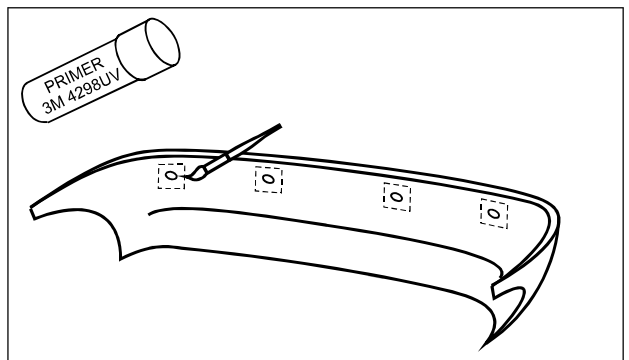
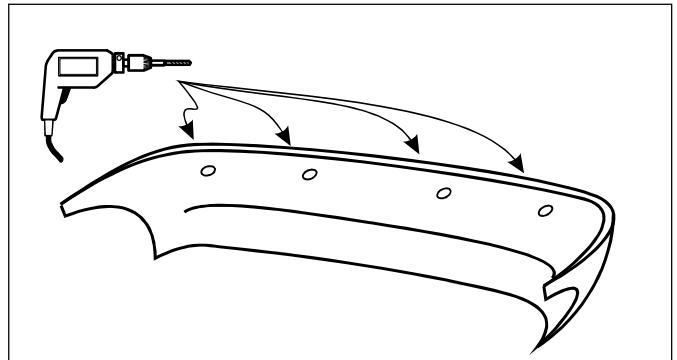
**C** 

**RETRO  
SENSORE  
REAR  
SENSOR**

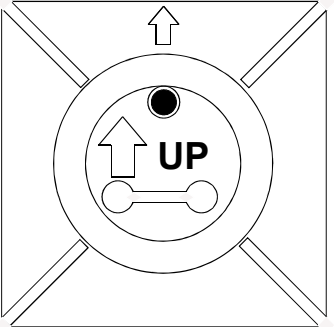
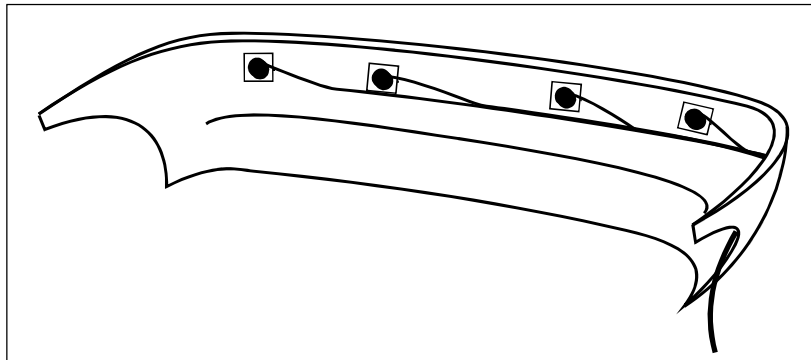

INTERRUTTORE	FUNZIONE
	<b>1</b> ↑ = Installazione su paraurti posteriore - Rear bumper ↓ = Installazione su paraurti anteriore - Front bumper
	<b>2</b> ↑ = Installazione con 4 sensori - 4 sensor ↓ = Installazione con 2 sensori - 2 sensor
	<b>3</b> ↑ = Lettura standard - Standard reading ↓ = Lettura ridotta - Reduced reading
	<b>4</b> ↑ = Sensibilità alta - High sensitivity ↓ = Sensibilità bassa - Low sensitivity

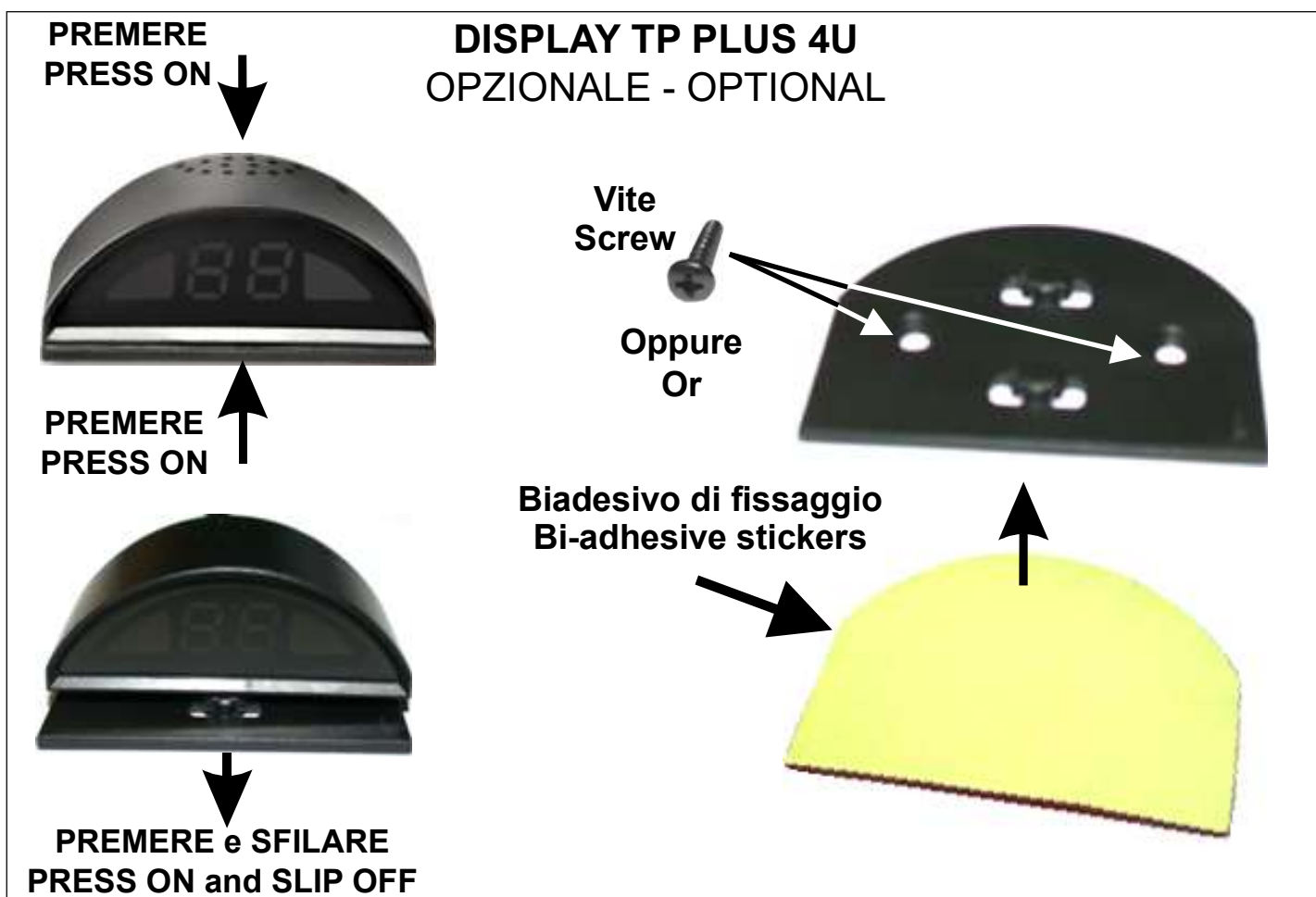
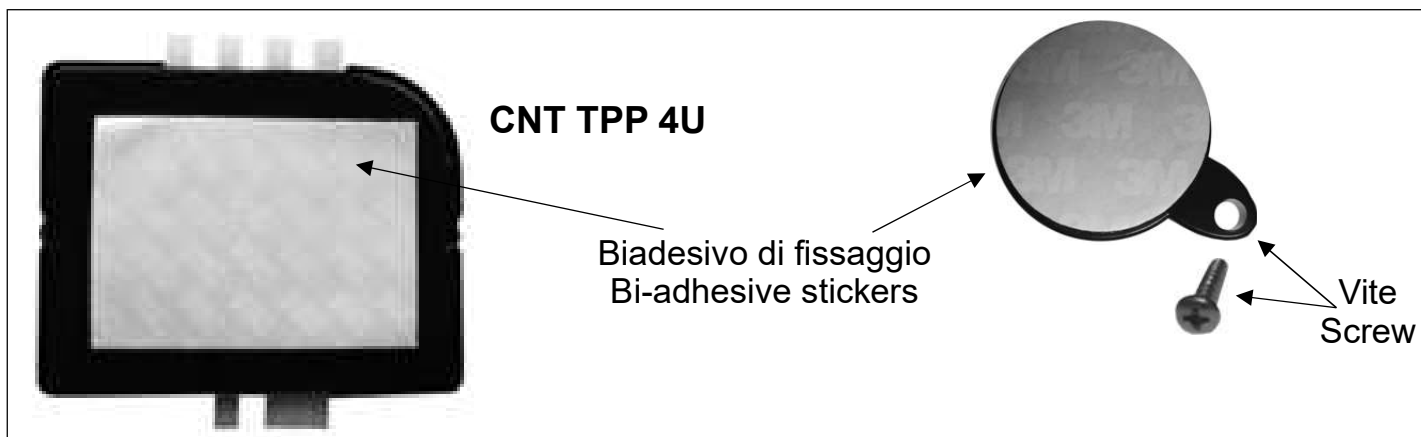

# ZONA DI RILEVAMENTO DEI SENSORI - IMPOSTAZIONE STANDARD

## ZONES OF DETECTION - FACTORY SETTINGS

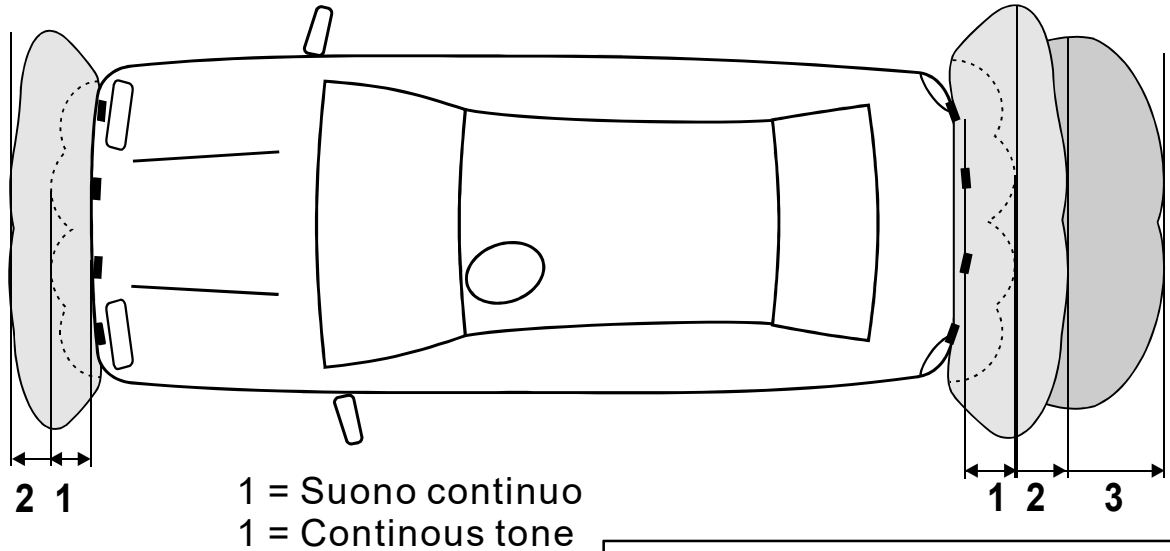
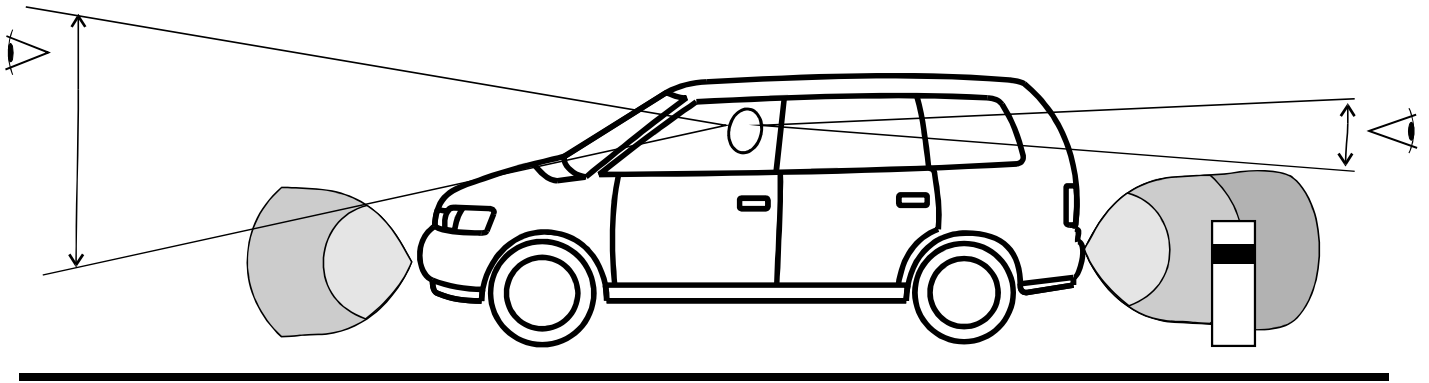

INSTALLAZIONE ANTERIORE (interruttore 1 ON) FRONT BUMPER (Switch 1 ON)		
ZONA - ZONE	<b>1</b>	<b>2</b>
Distanza (cm) Distance (cm)	<b>30</b>	<b>80</b>
(Interruttore 3 OFF) (Switch 3 OFF)		

INSTALLAZIONE POSTERIORE (interruttore 1 OFF) REAR BUMPER (Switch 1 OFF)			
ZONA - ZONE	<b>1</b>	<b>2</b>	<b>3</b>
Distanza (cm) Distance (cm)	<b>30</b>	<b>100</b>	<b>210</b>
Lettura standard (interruttore 3 OFF) Lettura standard (switch 3 OFF)			
ZONA - ZONE	<b>1</b>	<b>2</b>	<b>3</b>
Distanza (cm) Distance (cm)	<b>30</b>	<b>80</b>	<b>150</b>
Lettura ridotta (interruttore 3 ON) Reduced reading (switch 3 ON)			

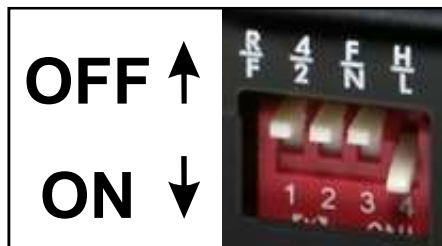

Tutti i diritti riservati. © 2022 Landi Renzo S.p.A.  
Con riserva di modifiche e di indicazioni errate.

All rights reserved. © 2022 Landi Renzo S.p.A.  
Subject to changes and incorrect information.